

# TOP LED, 3528, Neutral White CRI 80

## Feature

- ◆ Viewing angle:120 deg
- ◆ The materials of LED dice is InGaN
- ◆ 3.50mm×2.70mm×1.00mm
- ◆ RoHS compliant lead-free soldering compatible

**CC-WNHI3528DS-HH-F**

## Package Outline

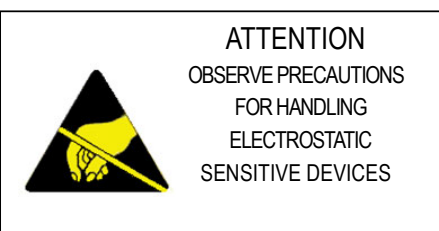
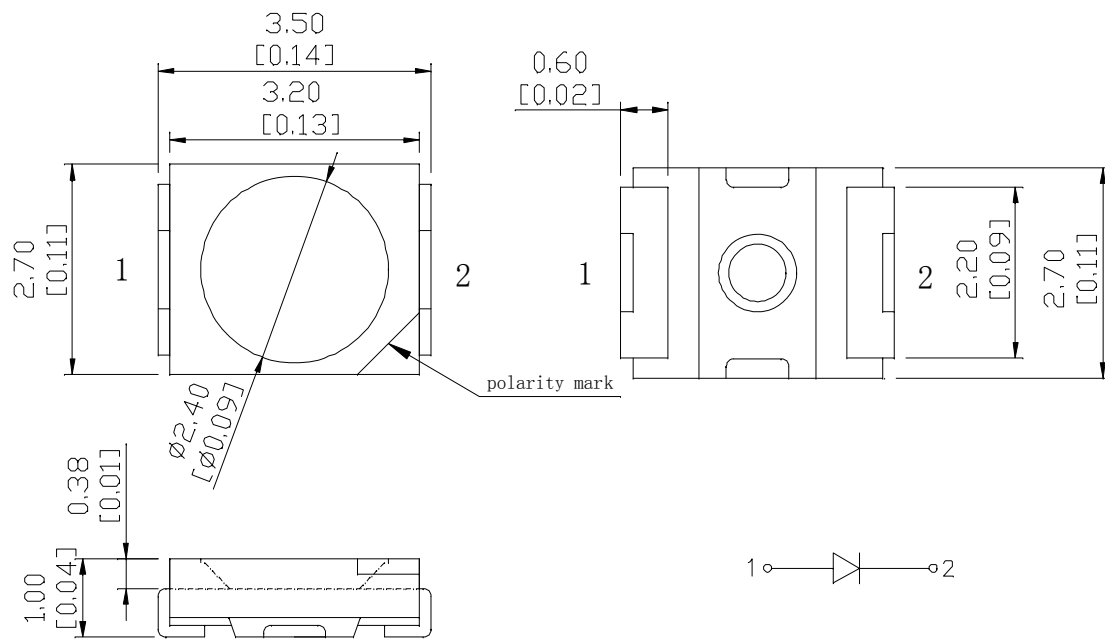

## NOTES:

1. All dimensions are in millimeters (inches);
2. Tolerances are  $\pm 0.2\text{mm}$  (0.008inch) unless otherwise noted.

### Absolute maximum ratings at Ta=25°C

Parameter	Symbol	Value	Unit
Forward current	If	40	mA
Reverse voltage	Vr	5	V
Operating temperature range	Top	-20 ~+85	°C
Storage temperature range	Tstg	-35 ~+85	°C
Pulse Forward Current	Ifp	100	mA
Electrostatic Discharge	ESD	2000(HBM)	V

### Electro-optical characteristics at Ta=25°C

Parameter	Test Condition	Symbol	Value			Unit	
			Min.	Typ.	Max.		
Forward voltage	Rank G2	If=30mA	Vf	2.9	--	3.0	V
	Rank H1			3.0	--	3.1	V
	Rank H2			3.1	--	3.2	V
	Rank I1			3.2	--	3.3	V
	Rank I2			3.3	--	3.4	V
	Rank J1			3.4	--	3.5	V
Luminous intensity	Rank OB0	If=30mA	Iv	3150	--	3500	mcd
	Rank OC0			3500	--	3850	mcd
	Rank OD0			3850	--	4300	mcd
Viewing angle at 50% Iv	If=30mA	2 θ 1/2	--	120	--	Deg	
Luminous flux	If=30mA	Φ	--	11	--	lm	
Color Rendering Index	If=30mA	CRI	80	--	--	--	
Reverse current	Vr=5V	Ir	--	--	10	μA	

NOTE: (Tolerance: Iv ±10%, Vf ±0.05V, X, Y ±0.005)

IFP Conditions: Pulse Width ≅ 10msec. and Duty ≅ 1/10.

## Chromaticity Bin

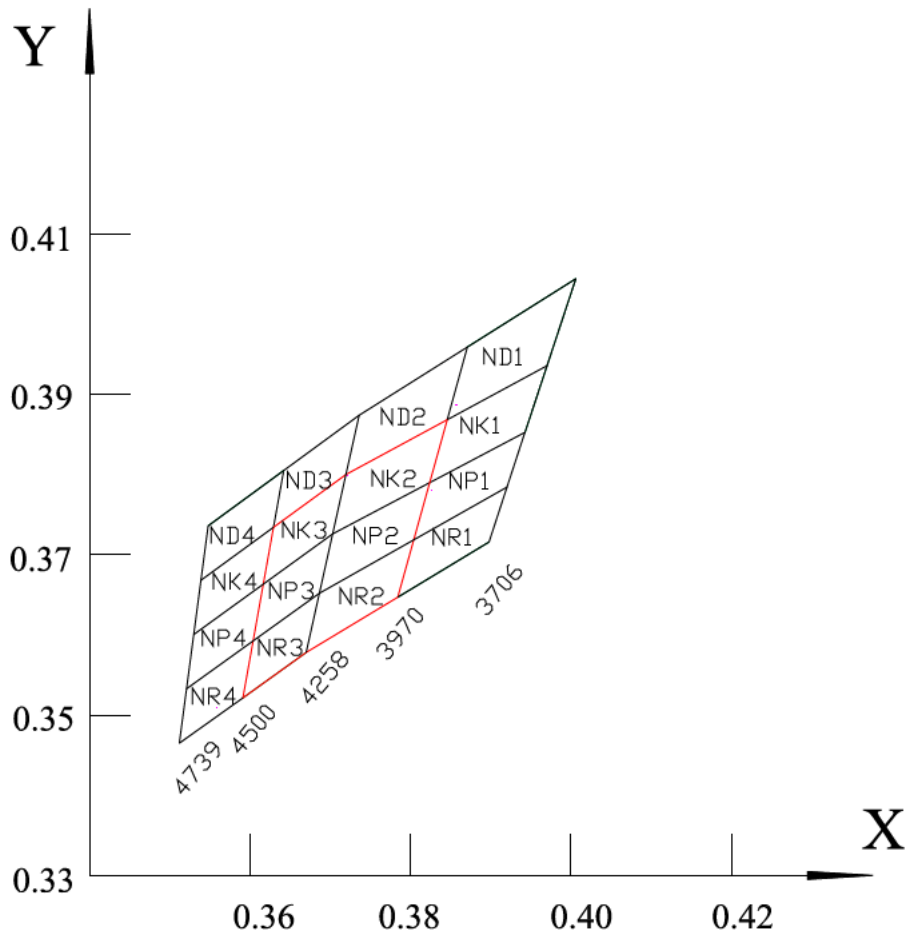

## Bin data:

BIN CODE	CIE-X1	CIE-Y1	CIE-X2	CIE-Y2	CIE-X3	CIE-Y3	CIE-X4	CIE-Y4
NK2	0.3720	0.3800	0.3845	0.3868	0.3824	0.3790	0.3703	0.3726
NK3	0.3629	0.3734	0.3720	0.3800	0.3703	0.3726	0.3617	0.3663
NP2	0.3703	0.3726	0.3824	0.3790	0.3804	0.3718	0.3687	0.3652
NP3	0.3617	0.3663	0.3703	0.3726	0.3687	0.3652	0.3604	0.3592
NR2	0.3687	0.3652	0.3804	0.3718	0.3784	0.3647	0.3670	0.3578
NR3	0.3604	0.3592	0.3687	0.3652	0.3670	0.3578	0.3591	0.3522

## Typical optical characteristics curves

### Spectral Distribution

Relative Intensity vs. Wavelength (Ta=25°C)

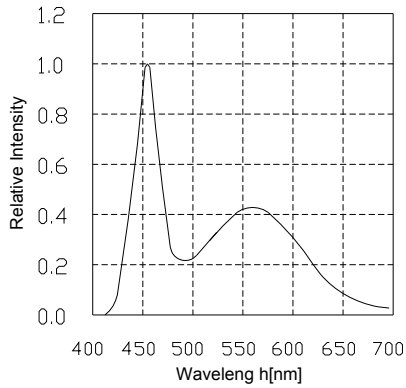

Forward Current vs. Forward Voltage (Ta=25°C)

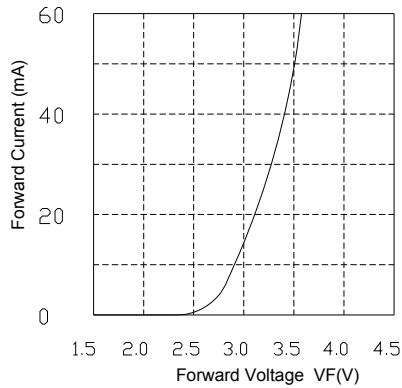

Relative Intensity vs. Forward Current (Ta=25°C)

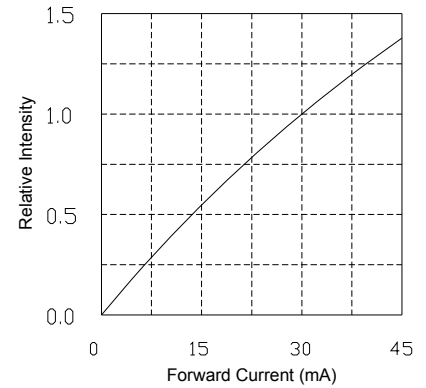

### Derating

Relative Intensity vs. Ambient Temperature

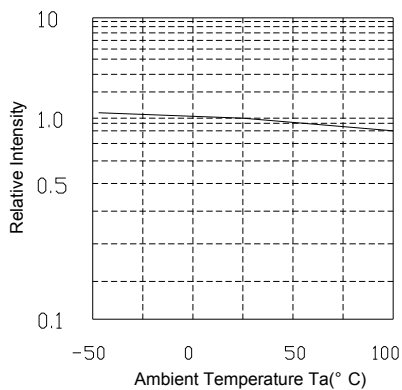

Maximum Forward Current vs. Ambient Temperature

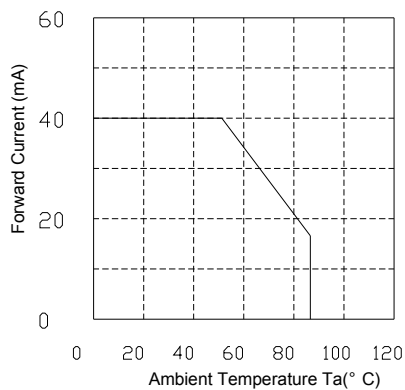

Forward Current vs. Chromaticity (Ta=25°C)

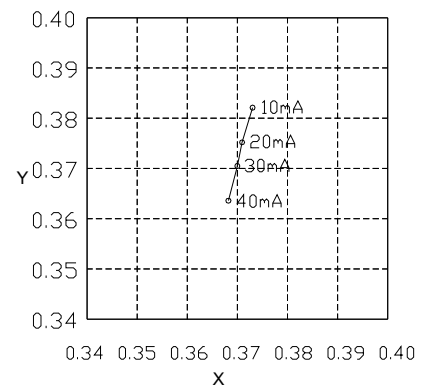

### Diagram characteristics of radiation

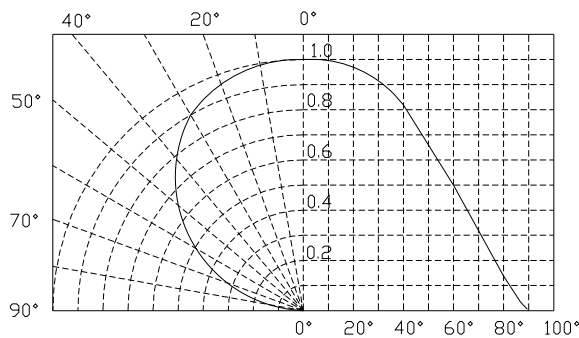

## Reflow profile

### ■ Soldering condition

- Recommended soldering conditions

Reflow Soldering		Hand Soldering	
Pre-heat	160~180°C	Temperature	300°C Max.
Pre-heat time	120 seconds Max.	Soldering time	3 second Max. (one time only)
Peak temperature	260°C Max.		
Soldering time	10 seconds Max.		
Condition	Refer to Temperature-profile		

- After reflow soldering rapid cooling should be avoided

### ■ Temperature-profile (Surface of circuit board)

Use the following conditions shown in the figure.

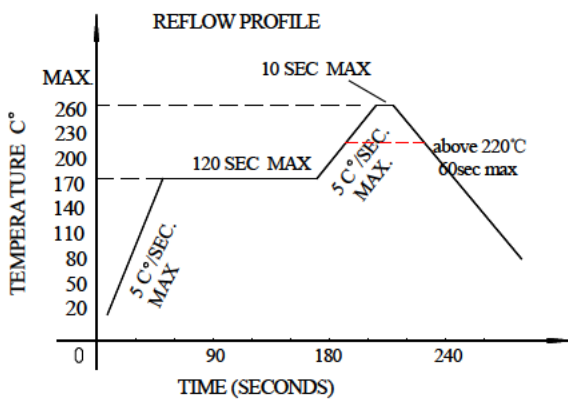

### RECOMMEND PAD DESIGN (Units: mm)

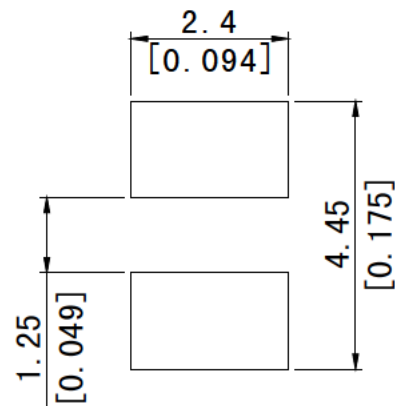

1. Reflow soldering should not be done more than two times
2. When soldering ,do not put stress on the LEDs during heating

### ■ Soldering iron

1. When hand soldering, keep the temperature of the iron under 300°C, and at that temperature keep the time under 3 sec.
2. The hand soldering should be done only a time
3. The basic spec is ≤5 sec. when the temperature of 260°C, do not contact the resin when hand soldering

### ■ Rework

1. Customer must finish rework within 5 sec under 260°C
2. The head of iron can not touch the resin
3. Twin-head type is preferred.

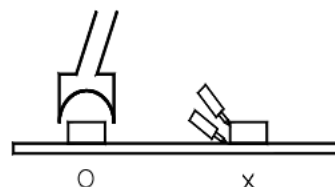

## ■ CAUTIONS

The encapsulated material of the LEDs is silicone . Therefore the LEDs have a soft surface on the top of package. The pressure to the top surface will be influence to the reliability of the LEDs. Precautions should be taken to avoid the strong pressure on the encapsulated part. So when using the picking up nozzle, the pressure on the silicone resin should be proper.

## Reliability

### (1) TEST ITEMS AND RESULTS

Type	Test Item	Ref. Standard	Test Conditions	Note	Number of Damaged
Environmental Sequence	Resistance to Soldering Heat(Reflow Soldering)	JESD22-B106	Tsld=260°C,10sec	2 times	0/22
	Temperature Cycle	JESD22-A104	-40°C 30min ↑↓5min 100°C 30min	300 cycle	0/22
	Thermal Shock	JESD22-A106	-40°C 15min ↑↓ 100°C 15min	300 cycle	0/22
	High Temperature Storage	JESD22-A103	T <sub>a</sub> =100°C	1000 hrs	0/22
	Low Temperature Storage	JESD22-A119	T <sub>a</sub> =-40°C	1000 hrs	0/22
Operation Sequence	Life Test	JESD22-A108	T <sub>a</sub> =25°C I <sub>F</sub> =30mA	1000 hrs	0/22
	High Humidity Heat Life Test	JESD22-A101	60°C RH=90% I <sub>F</sub> =30mA	1000 hrs	0/22

### (2) CRITERIA FOR JUDGING THE DAMAGE

Item	Symbol	Test Conditions	Criteria for Judgement	
			Min.	Max.
Forward Voltage	VF	IF=30mA	—	U.S.L*)×1.1
Reverse Current	IR	VR=5V	—	U.S.L*)×2.0
Luminous Intensity	IV	IF=30mA	L.S.L**)×0.7	—

U.S.L.: Upper Standard Level

L.S.L.: Lower Standard Level

## Packaging Specifications

### ● Feeding Direction

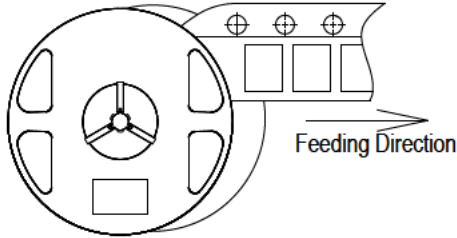

### ● Dimensions of Reel (Unit: mm)

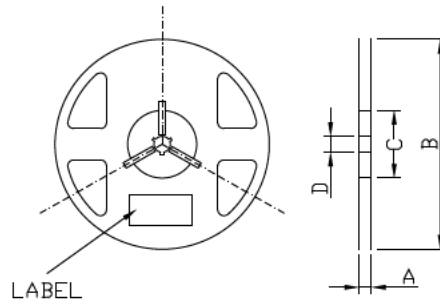

A	8.0 ± 0.1mm
B	178 ± 1mm
C	60 ± 1mm
D	13.0 ± 0.5mm

### ● Dimensions of Tape (Unit: mm)

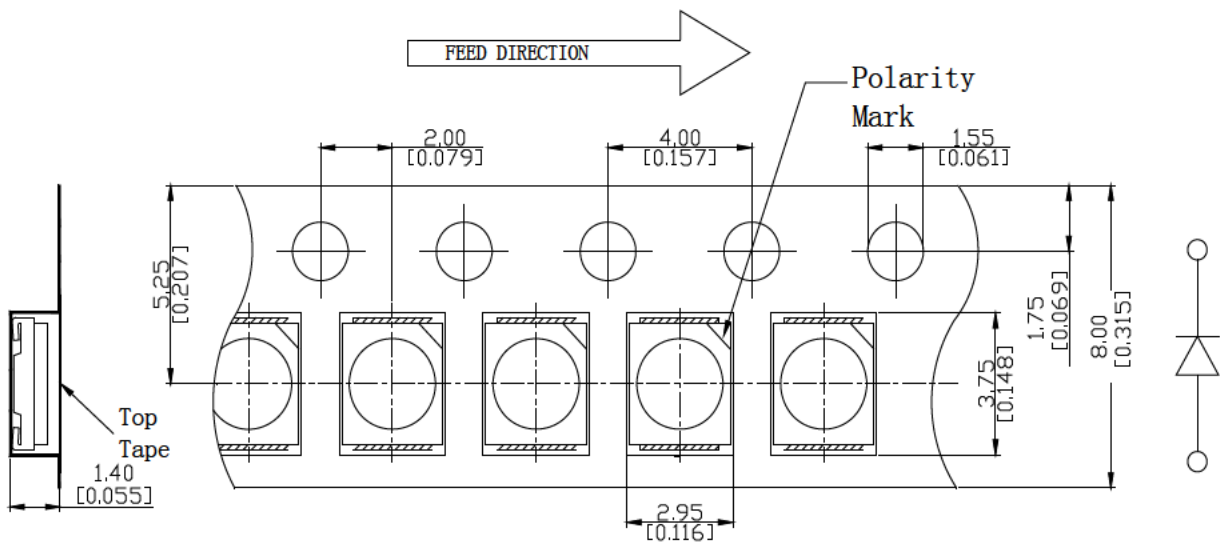

### ● Arrangement of Tape

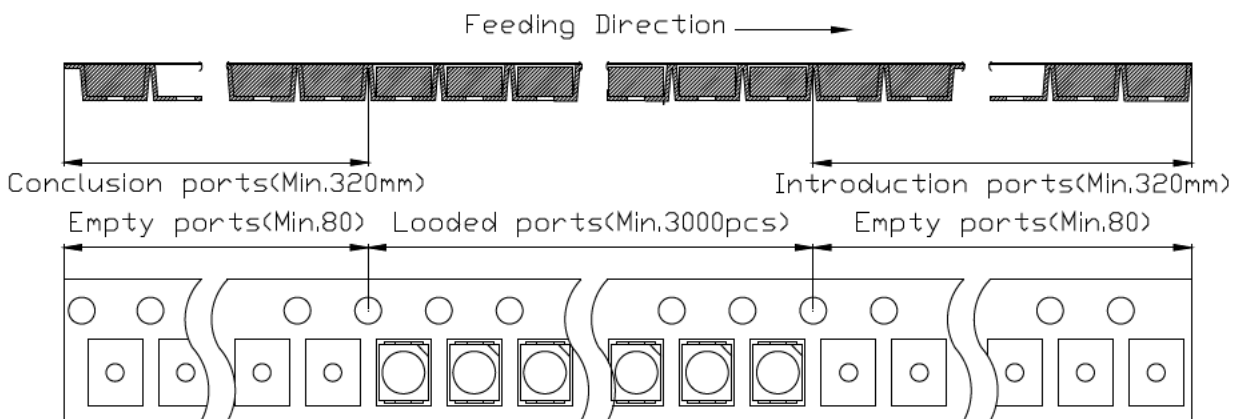



## NOTES

1. Empty component pockets are sealed with top cover tape;
2. The maximum number of missing lamps is two;
3. The cathode is oriented towards the tape sprocket hole in accordance with ANSI/EIA RS-481 specifications.
4. 3,000 pcs/ Reel.

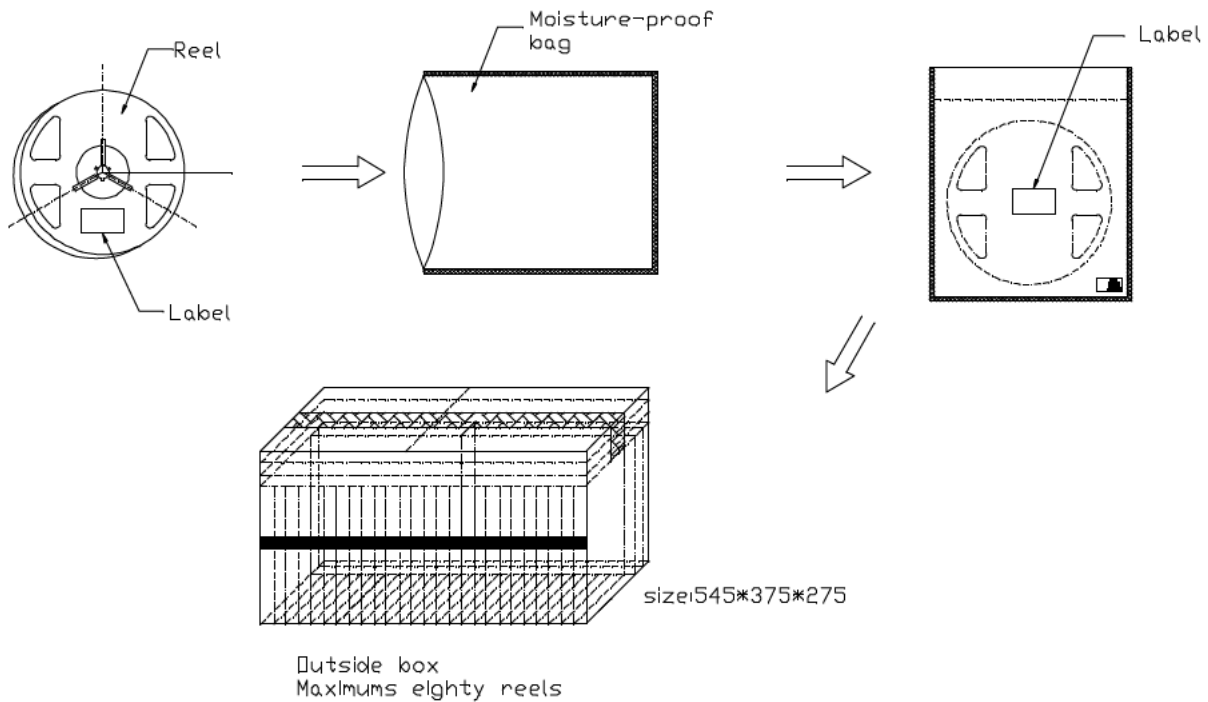
## Packaging specifications



■ Label

PART NO:	
	
LOT NO:	
	
BIN CODE:	
	
IV:	VF: X/Y:
QTY:	PCS
DATE:	

## CAUTIONS

### Package specifications

Reeled products (numbers of products are 3,000pcs) packed in a seal off moisture-proof bag along with a desiccant one by one, Eighty moisture-proof bag of maximums are put the outside box (size: about 545mm x about 375mm x about 275mm) Together with buffer material, and it is packed. (Part No., Lot No., quantity should appear on the label on the moisture-proof bag, part No. And quantity should appear on the label on the cardboard box.) The number of the loading steps of outside box (cardboard box) has two steps.

### Storage conditions

#### Before opening the package:

The LEDs should be kept at 30°C or less and 70%RH or less. The LEDs should be used within a year. When storing the LEDs, moisture proof packaging with absorbent material (silica gel) is recommended.

#### After opening the package:

The LEDs should be kept at 30°C or less and 50%RH or less. If unused LEDs remain, they should be stored in moisture proof packages, such as sealed containers with packages of moisture absorbent material (silica gel). It is also recommended to return the LEDs to the original moisture proof bag and to reseal the moisture proof bag again.